

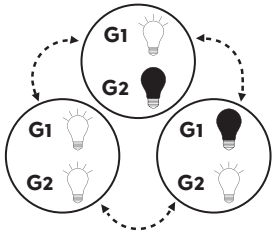

EASi DISK GROUP SELECTOR



GROUP 1 + GROUP 2



GROUP 1 + GROUP 3

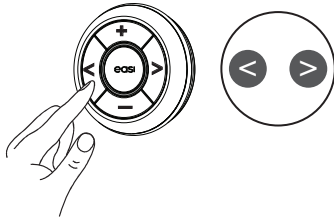
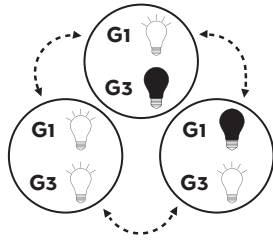

GROUP 2 + GROUP 3

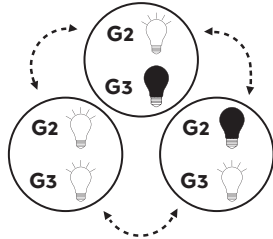

GROUP 1 + GROUP 2 + GROUP 3

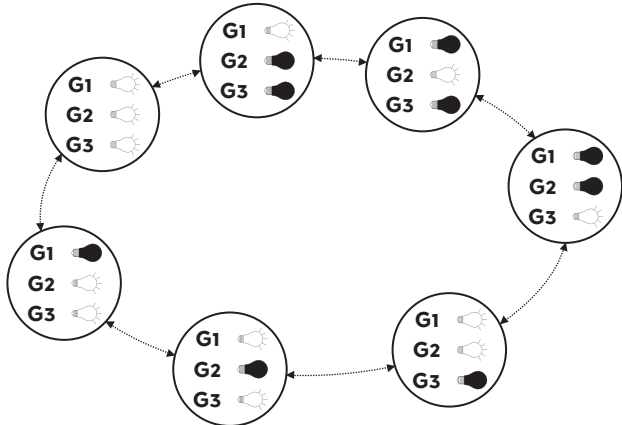

EASi DISK D-M SELECTOR

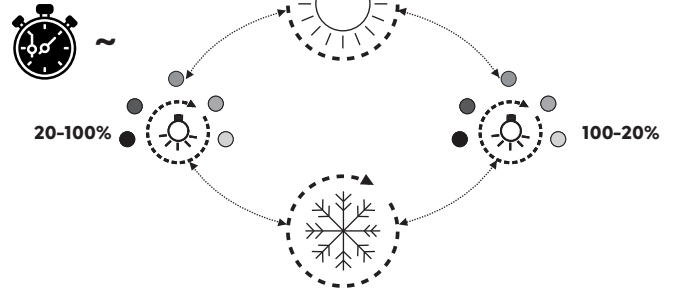
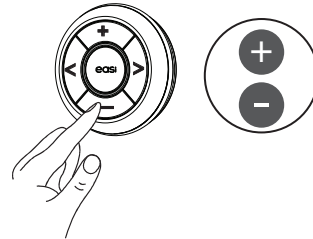
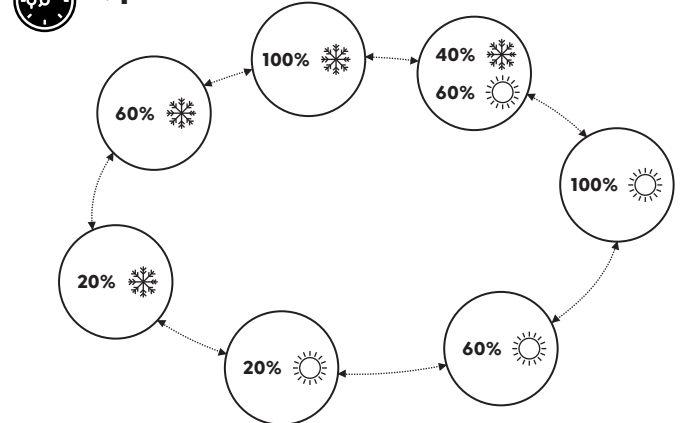

EASi DISK SETUP



D-MOTION (D-M)

STANDARD (W)

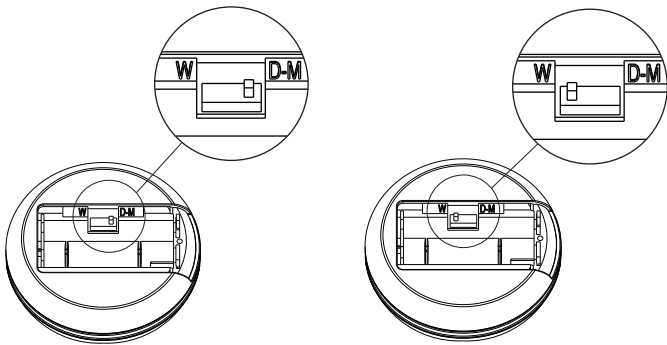

EASi DISK STANDARD SELECTOR





EASi DISK

2X AAA 1,5V
ALKALINE LR03 / 24A

EASi DISK

EASi DRIVER GROUP SETUP

SET GROUP 1
SET GROUP 2
SET GROUP 3

max. 15 mt.
max. 7 pcs.

EASi DISK PAIRING

60"
x1

> 5"

220-240 VAC